

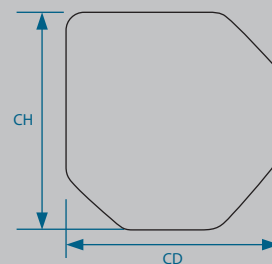

VEGA SCREEN JUNO MANUAL

- Ideal for classroom or small to medium sized groups
- Easy to operate. No extra accessories needed
- Self-locking device for reliable and safe operation
- Convenient to pull and extend, easy to be adjusted to any interval to fit variety of projection formats
- Available in ceiling mount and wall mount

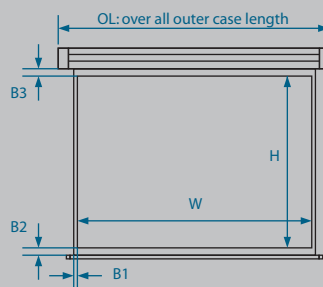

Specifications

Product Code	Format	Screen Size WxH (inch)	Viewing Area (mm)		B1 (mm)	B2 (mm)	B3 (mm)	OL (mm)		CH x CD (mm)	Packing Dimension L x W x H (mm)	N.W. (kg)	G.W. (kg)
			Height	Width				Length	Diameter				
VG-JM50X50MW	Square 1:1	50" x 50"	1270	1270	30	30	40	1406	φ 55	63 x 63	1518 x 100 x 95	5.50	6.50
VG-JM60X60MW		60" x 60"	1524	1524	30	30	40	1660	φ 55	63 x 63	1772 x 100 x 95	6.10	7.00
VG-JM70X70MW		70" x 70"	1778	1778	30	30	40	1914	φ 55	70.5 x 70.5	2026 x 100 x 95	7.50	8.40
VG-JM84X84MW		84" x 84"	2134	2134	40	40	40	2290	φ 64	70.5 x 70.5	2402 x 115 x 105	8.90	10.00
VG-JM50X67MW	Video 4:3	84" (50" x 67")	1280	1707	30	30	40	1843	φ 55	63 x 63	1955 x 100 x 95	7.00	8.00
VG-JM60X80MW		100" (60" x 80")	1524	2032	40	40	40	2188	φ 64	70.5 x 70.5	2300 x 115 x 105	8.10	9.00
VG-JM48X84MW	HDTV 16:9	97" (48" x 84")	1200	2134	40	40	590	2290	φ 64	70.5 x 70.5	2402 x 115 x 105	9.00	10.00



VEGA SCREEN JUNO SYNCHRONOUS ELECTRIC

- Ideal projection screen for home theater movies, classroom training or conference room presentations
- Pre-wired power cord with integrated switch for fast installation
- The projection surface utilizes unique materials creating a smooth surface for superior image quality
- Back of fabric is completely block out, no light pass through, possible to hang screen right on the window
- Synchronous motor driving device, free to stop at any location
- With manual switch. Remote control is optional

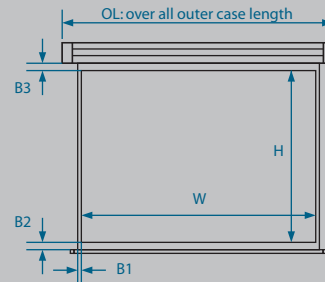
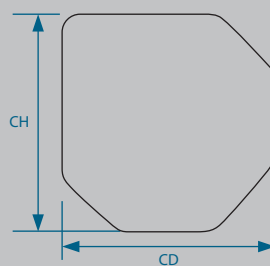
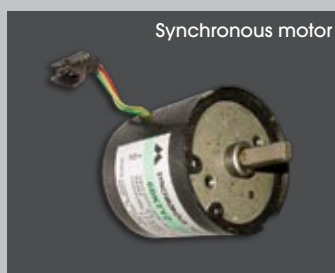

Specifications

Product Code	Format	Screen Size WxH (inch)	Viewing Area (mm)		B1 (mm)	B2 (mm)	B3 (mm)	OL (mm)		CH x CD (mm)	Packing Dimension L x W x H (mm)	N.W. (kg)	G.W. (kg)
			Height	Width				Length	Diameter				
VG-JS50X50MW	Square 1:1	50" x 50"	1270	1270	30	30	40	1406	φ 55	63 x 63	1518 x 100 x 95	5.50	6.50
VG-JS60X60MW		60" x 60"	1524	1524	30	30	40	1660	φ 55	63 x 63	1772 x 100 x 95	6.10	7.00
VG-JS70X70MW		70" x 70"	1778	1778	30	30	40	1914	φ 55	70.5 x 70.5	2026 x 100 x 95	7.50	8.40
VG-JS84X84MW		84" x 84"	2134	2134	40	40	40	2290	φ 64	70.5 x 70.5	2402 x 115 x 105	8.90	10.00
VG-JS50X67MW	Video 4:3	84" (50" x 67")	1280	1707	30	30	40	1843	φ 55	63 x 63	1955 x 100 x 95	7.00	8.00
VG-JS60X80MW		100" (60" x 80")	1524	2032	40	40	40	2188	φ 64	70.5 x 70.5	2300 x 115 x 105	8.10	9.00
VG-JS48X84MW	HDTV 16:9	97" (48" x 84")	1200	2134	40	40	590	2290	φ 64	70.5 x 70.5	2402 x 115 x 105	9.00	10.00

VEGA SCREEN JUNO Tripod



- Octagon unbreakable steel casing
- Lightweight and durable structure for mobility
- 7 levels of built-in keystone eliminator neutralizes picture distortion
- Fast and easy to setup and retract
- Flat matte white screen for perfect images
- Strong and durable tripod stand

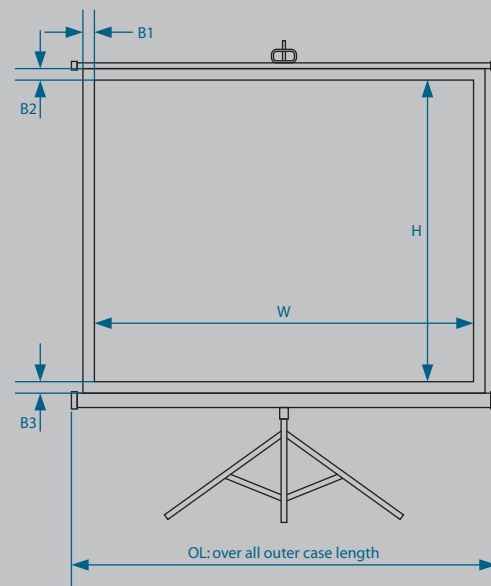
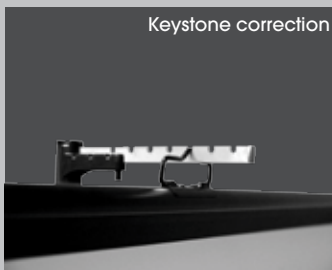

Specifications

Product Code	Format	Screen Size WxH (inch)	Viewing Area (mm)		B1 (mm)	B2 (mm)	B3 (mm)	OL (mm)		Packing Dimension L x W x H (mm)	N.W. (kg)	G.W. (kg)
			Height	Width				Length	Diameter			
VG-JP50X50MW	Square 1:1	50" x 50"	1270	1270	30	40	30	1405	φ 65	1465 x 170 x 125	7.18	8.68
VG-JP60X60MW		60" x 60"	1524	1524	30	40	30	1659	φ 65	1720 x 170 x 125	7.70	10.00
VG-JP70X70MW		70" x 70"	1778	1778	30	40	30	1913	φ 65	1975 x 170 x 125	8.84	10.95
VG-JP84X84MW		84" x 84"	2134	2134	30	40	30	2269	φ 65	2330 x 170 x 125	11.17	13.30
VG-JP96X96MW		96" x 96"	2360	2360	40	40	40	2495	φ 65	2575 x 170 x 125	11.60	13.80
VG-JP50X67MW	Video 4:3	84" (50" x 67")	1280	1707	30	40	30	1842	φ 65	1900 x 170 x 125	8.96	11.10
VG-JP60X80MW		100" (60" x 80")	1524	2032	40	40	40	2167	φ 65	2245 x 170 x 125	10.32	12.50
VG-JP72X96MW		120" (72" x 96")	1829	2360	40	40	40	2495	φ 65	2575 x 170 x 125	11.50	13.70
VG-JP48X84MW	HDTV 16:9	97" (48" x 84")	1207	2134	30	400	40	2269	φ 65	2330 x 170 x 125	10.62	12.80
VG-JP54X96MW		110" (54" x 96")	1369	2360	30	400	40	2495	φ 65	2575 x 170 x 125	11.60	13.80